

snorkel

SL30SL

SL26SL



CE

OPERATOR'S

MANUAL

Serial Number SL26SL-01-xxxx00093 and after
Serial Number SL30-01-060210 and after

Part Number 514949-000-EN
July 2019

SL26/30SL Series

ENGLISH

When contacting Snorkel for service or parts information, be sure to include the model and serial numbers from the equipment name plate. Should the name plate be missing, the serial number is also stamped on top of the chassis above the front axle pivot.

The serial number is available on nameplate

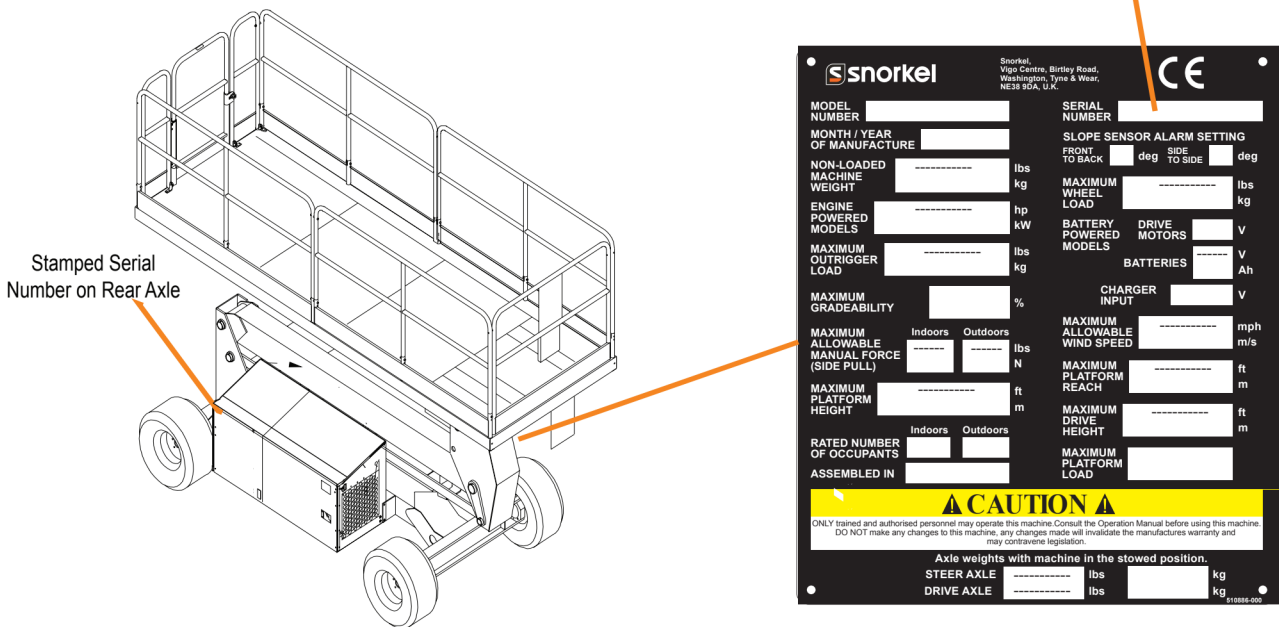

Figure 1: Serial number location on SL26/30SL

USA

TEL: +1 (559)443 6600
FAX: +1 (559)268 2433

Europe

TEL: +44 (0) 1952 200
FAX: +44 (0) 1952 229

www.snorkellifts.com

SAFETY RULES

WARNING

All personnel shall carefully read, understand and follow all safety rules and operating instructions before operating or performing maintenance on any SNORKEL aerial work platform.

ELECTROCUTION HAZARD TIP OVER HAZARD COLLISION HAZARD FALL HAZARD TRAPPING/CRUSHING HAZARD

				
THIS MACHINE IS NOT INSULATED	NEVER ELEVATE THE PLATFORM OR DRIVE THE MACHINE WHILE ELEVATED UNLESS THE MACHINE IS ON A FIRM LEVEL SURFACE	NEVER POSITION THE PLATFORM WITHOUT FIRST CHECKING FOR OVERHEAD OBSTRUCTIONS OR OTHER HAZARDS	NEVER CLIMB, STAND OR SIT ON PLATFORM GUARDRAILS OR MIDRAIL	BEWARE OF CRUSHING HAZARD WHEN HOLDING HANDRAILS WHILE THE PLATFORM IS MOVING IN CLOSE PROXIMITY TO OTHER OBJECTS

- **USE OF THE AERIAL WORK PLATFORM:** This aerial work platform is intended to lift a person or persons and their tools including material needed for a job. The work platform is designed to be used for repair and assembly jobs **ONLY** at overhead work places (ceilings, cranes, roof structures, buildings, etc.).
The use and operation of the aerial work platform as a lifting tool or a crane is **prohibited!**
Climbing up the railing of the platform, standing on or stepping from the platform unto buildings, steel or prefab concrete structures etc is **prohibited!**
NEVER use the machine if damaged, not functioning properly, has damaged or missing decals.
NEVER attach notice boards etc. to the platform as this will increase the wind loading.
- **INSULATION:** The aerial work platform is not insulated. It is imperative to keep a safe distance from live parts or electrical equipments. **DO NOT** get closer than the minimum distance recommended by the "National Regulations".
- **PLATFORM CAPACITY:** Exceeding the specified permissible maximum load is **prohibited!** Refer to platform capacity on page 24 for details.
- **MANUAL FORCE:** **NEVER** exceed the manual force allowed for this machine. Refer to special limitations on page 9 for details.
- **LOAD DISTRIBUTION:** Ensure that all loads are distributed evenly on the platform.
- **SURVEILLANCE:** **NEVER** operate the machine without first surveying the work area for surface hazards such as holes, drop-offs, bumps, curbs or debris and avoiding them.
- **WHEEL LOAD:** **OPERATE** the machine only on surfaces capable of supporting wheel load.
- **WIND SPEED:** **NEVER** operate the machine when the wind speed exceeds the machine's wind speed rating. Refer to the Beaufort scale for details.
- **EMERGENCY STOP:** In case of an emergency, push the **EMERGENCY STOP** switch to de-activate all powered functions.
- **ALARM:** If the alarm sounds while the platform is elevated, **STOP** operation immediately and carefully lower the platform. Move the machine to a firm, level surface.
- **SWING GATE:** Dismantling the entry gate or other railing components is **prohibited!** Always make certain that the entry gate is closed and securely locked.
It is **prohibited** to keep the entry gate in an open position when the platform is raised.
Extending the height of the platform by placing ladders, scaffolds or similar devices on the platform is **prohibited!**
- **SERVICING:** **NEVER** perform service on machine while platform is elevated without blocking the elevating assembly. Refer to "maintenance" for details.
- **INSPECT:** the machine thoroughly for cracked welds, loose or missing hardware, hydraulic leaks, loose wire connections and damaged cables or hoses before usage.
- **DECALS:** **VERIFY** that all labels are in place and legible before using the machine.
- **BATTERIES:** **NEVER** charge batteries near sparks or open flame. Charging batteries emit explosive hydrogen gas.
- **STORAGE:** **AFTER USE**, secure the work platform from unauthorised use by turning the key switch off and removing the key.
- **HARNES:** Harness attachment points are provided on the platform and the manufacturer recommends the usage of a fall restraint harness especially where required by national safety regulations.
Modifications to the aerial work platform are prohibited or permissible only at the approval of the manufacturer.
- **ENVIRONMENTAL TEMPERATURE LIMITATION:** The machine is primarily for use in normal ambient temperatures and conditions ranging between 50C to -20C

SAFETY NOTICE

Harness attachment points are provided in the platform and the manufacturer recommends the usage of a fall restraint harness, especially where required by national safety regulations.

All harness attachment points on SNORKEL vehicles have been tested with a force of 3,650 lbs (16.3 KN) per person.

See below examples of harness attachment points used on SNORKEL vehicles with their corresponding rating;

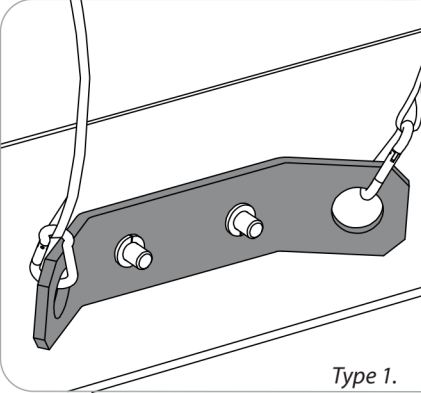
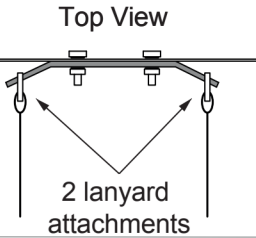
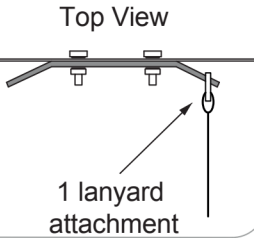
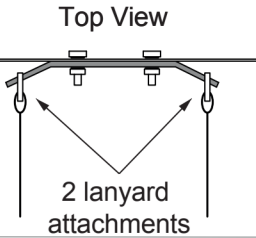
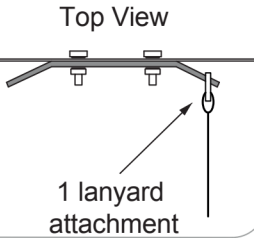
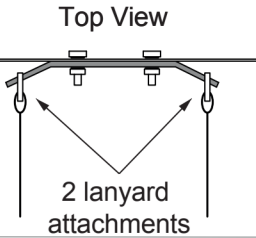
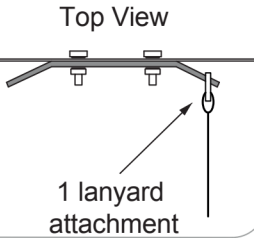
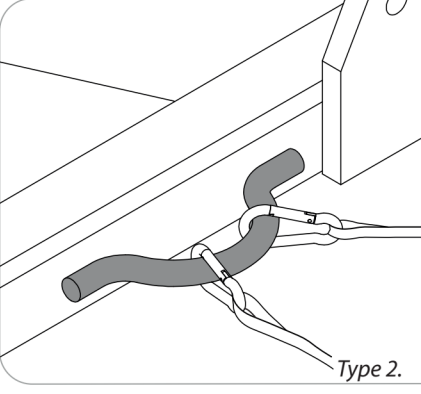
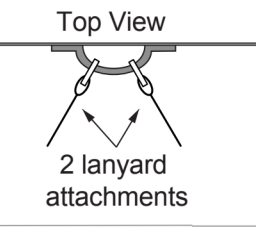
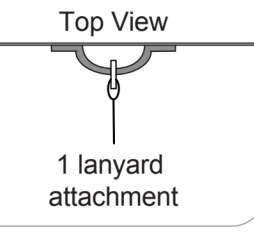
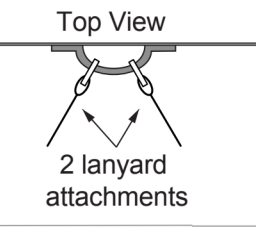
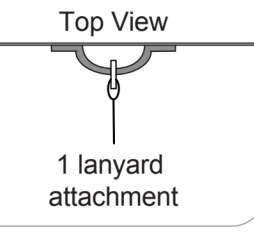
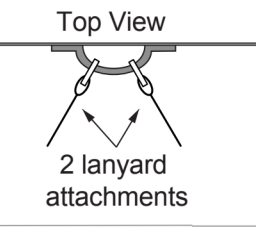
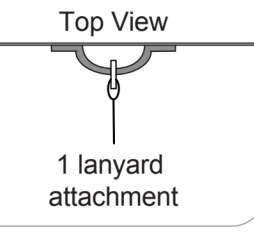
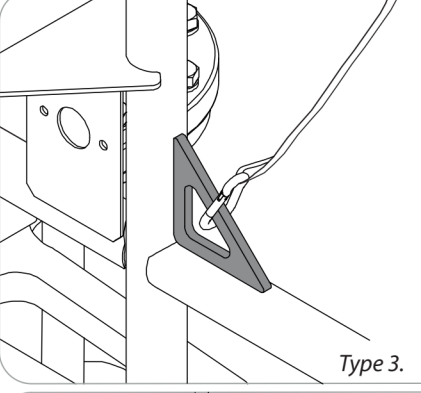
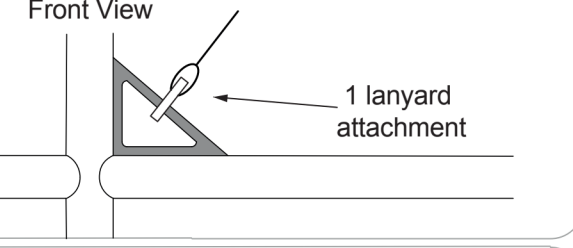
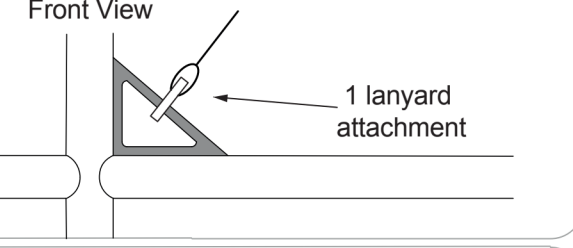
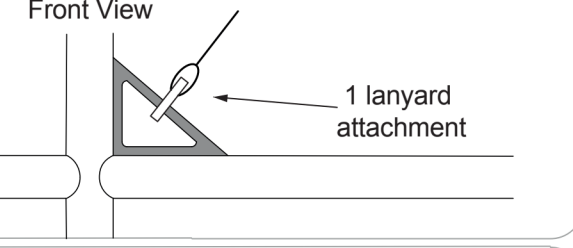
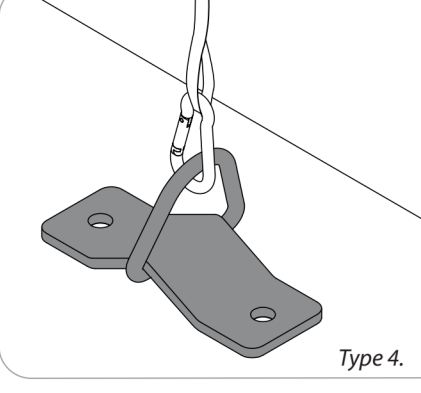
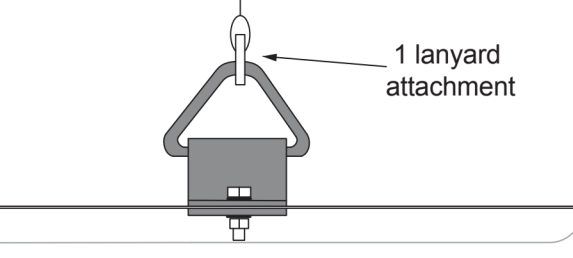
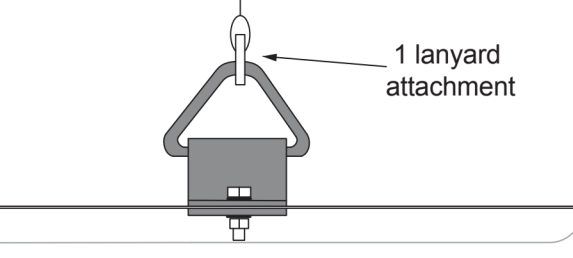
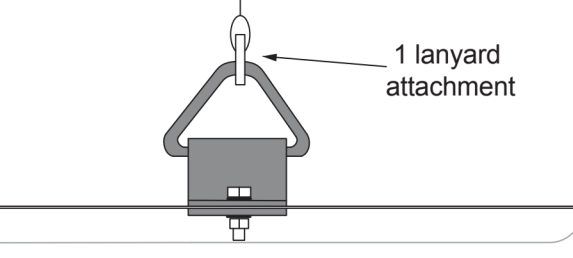
 <p style="text-align: right; margin-top: 10px;"><i>Type 1.</i></p>	<p>Harness attachment point Type 1. is rated for one lanyard attachment per loop as shown in the illustrations depending upon platform occupancy rating (see operators manual & decals).</p> <table border="1" style="width: 100%; border-collapse: collapse;"> <tr> <td style="width: 50%; text-align: center; padding: 5px;"> <p>Top View</p>  <p>2 lanyard attachments</p> </td> <td style="width: 50%; text-align: center; padding: 5px;"> <p>Top View</p>  <p>1 lanyard attachment</p> </td> </tr> </table>	<p>Top View</p>  <p>2 lanyard attachments</p>	<p>Top View</p>  <p>1 lanyard attachment</p>
<p>Top View</p>  <p>2 lanyard attachments</p>	<p>Top View</p>  <p>1 lanyard attachment</p>		
 <p style="text-align: right; margin-top: 10px;"><i>Type 2.</i></p>	<p>Harness attachment point Type 2. is rated for two lanyard attachments per loop as shown in the illustrations depending upon platform occupancy rating (see operators manual & decals).</p> <table border="1" style="width: 100%; border-collapse: collapse;"> <tr> <td style="width: 50%; text-align: center; padding: 5px;"> <p>Top View</p>  <p>2 lanyard attachments</p> </td> <td style="width: 50%; text-align: center; padding: 5px;"> <p>Top View</p>  <p>1 lanyard attachment</p> </td> </tr> </table>	<p>Top View</p>  <p>2 lanyard attachments</p>	<p>Top View</p>  <p>1 lanyard attachment</p>
<p>Top View</p>  <p>2 lanyard attachments</p>	<p>Top View</p>  <p>1 lanyard attachment</p>		
 <p style="text-align: right; margin-top: 10px;"><i>Type 3.</i></p>	<p>Harness attachment point Type 3. is rated for one lanyard attachment per loop as shown in the illustrations depending upon platform occupancy rating (see operators manual & decals).</p> <table border="1" style="width: 100%; border-collapse: collapse;"> <tr> <td style="width: 100%; text-align: center; padding: 5px;"> <p>Front View</p>  <p>1 lanyard attachment</p> </td> </tr> </table>	<p>Front View</p>  <p>1 lanyard attachment</p>	
<p>Front View</p>  <p>1 lanyard attachment</p>			
 <p style="text-align: right; margin-top: 10px;"><i>Type 4.</i></p>	<p>Harness attachment point Type 4. is rated for one lanyard attachment per loop as shown in the illustrations depending upon platform occupancy rating (see operators manual & decals).</p> <table border="1" style="width: 100%; border-collapse: collapse;"> <tr> <td style="width: 100%; text-align: center; padding: 5px;">  <p>1 lanyard attachment</p> </td> </tr> </table>	 <p>1 lanyard attachment</p>	
 <p>1 lanyard attachment</p>			

NOTE: There can be more harness attachment points per machine than the maximum number of occupants allowed in a platform. Refer to the platform decal & specifications table listed in the operators manual for the correct occupancy rating before use.

SAFETY NOTICE

NOTE:

1. To bypass any safety equipment is **prohibited** and presents a danger for the person/persons on the aerial work platform and in its working range.
2. Modification to the aerial work platform is **prohibited** or permissible only at the approval of Snorkel.
3. The driving of MEWP'S on the public highway is subject to national traffic regulations.
4. It is important to ensure that the machine meets the requirements of stability during use, transportation, assembly, dismantling when out of service, testing or foreseeable breakdowns.
5. Never use a machine that is damaged or not functioning properly. Verify that all labels are in place and legible before using.

CONTENTS

INTRODUCTION	7
GENERAL DESCRIPTION	7
SPECIAL LIMITATIONS	8
PLATFORM CAPACITY	8
MANUAL FORCE	8
BEAUFORT SCALE	8
SPECIAL LIMITATIONS	8
LIFT OVERLOAD ALARM	9
CONTROLS/PRE-OPERATION	10
PLATFORM CONTROLS AND INDICATORS	10
CHASSIS CONTROLS AND INDICATORS	10
PRE-OPERATION SAFETY INSPECTION	11
SYSTEM FUNCTION INSPECTION	12
OPERATION	13
STARTING THE MACHINE	13
STEERING	13
ELEVATING THE PLATFORM	13
LOWERING THE PLATFORM	13
TRAVEL WITH THE PLATFORM LOWERED	13
TRAVEL WITH THE PLATFORM ELEVATED	14
LEVELLING THE PLATFORM	14
HOUR METER	14
AC GENERATOR (OPTIONAL)	14
PLATFORM EXTENSION (SL26 SPEED LEVEL ONLY)	15
PLATFORM RETRACTION (SL26 SPEED LEVEL ONLY)	15
FOLD DOWN GUARDRAILS	15
FOLD DOWN PROCEDURE	15
UNFOLD PROCEDURE	16
EMERGENCY PROCEDURE	17
TOWING OR WINCHING	17
BRAKE RELEASE PUMP	17
EMERGENCY LOWERING	18
TRANSPORTATION	19
PREPARATION FOR SHIPMENT	19
LIFTING BY CRANE	19
DRIVING OR WINCHING ONTO A TRACK OR TRAILER	19
AFTER USE EACH DAY	19
MAINTENANCE	20
BLOCKING THE ELEVATING ASSEMBLY	20
INSTALLATION	20
REMOVAL	20
BATTERY MAINTENANCE (FOR MAINTENANCE BATTERIES ONLY)	20
INSPECTION AND MAINTENANCE	22
DAILY PREVENTATIVE MAINTENANCE SCHEDULE	23
SPECIFICATIONS	24
SPECIFICATIONS	25
WASTE REMOVAL AND DISPOSAL	26

INTRODUCTION

This manual covers the operation of the SL26/30 Speed level series Self-Propelled Work Platforms. This manual must be stored on the machine at all times.

GENERAL DESCRIPTION

- 1. Platform
- 2. Elevating Assembly
- 3. Chassis
- 4. Power Module
- 5. Control Module
- 6. Platform Controls
- 7. Manual Case
- 8. Chassis Controls
- 9. Hydraulic Fluid Reservoir

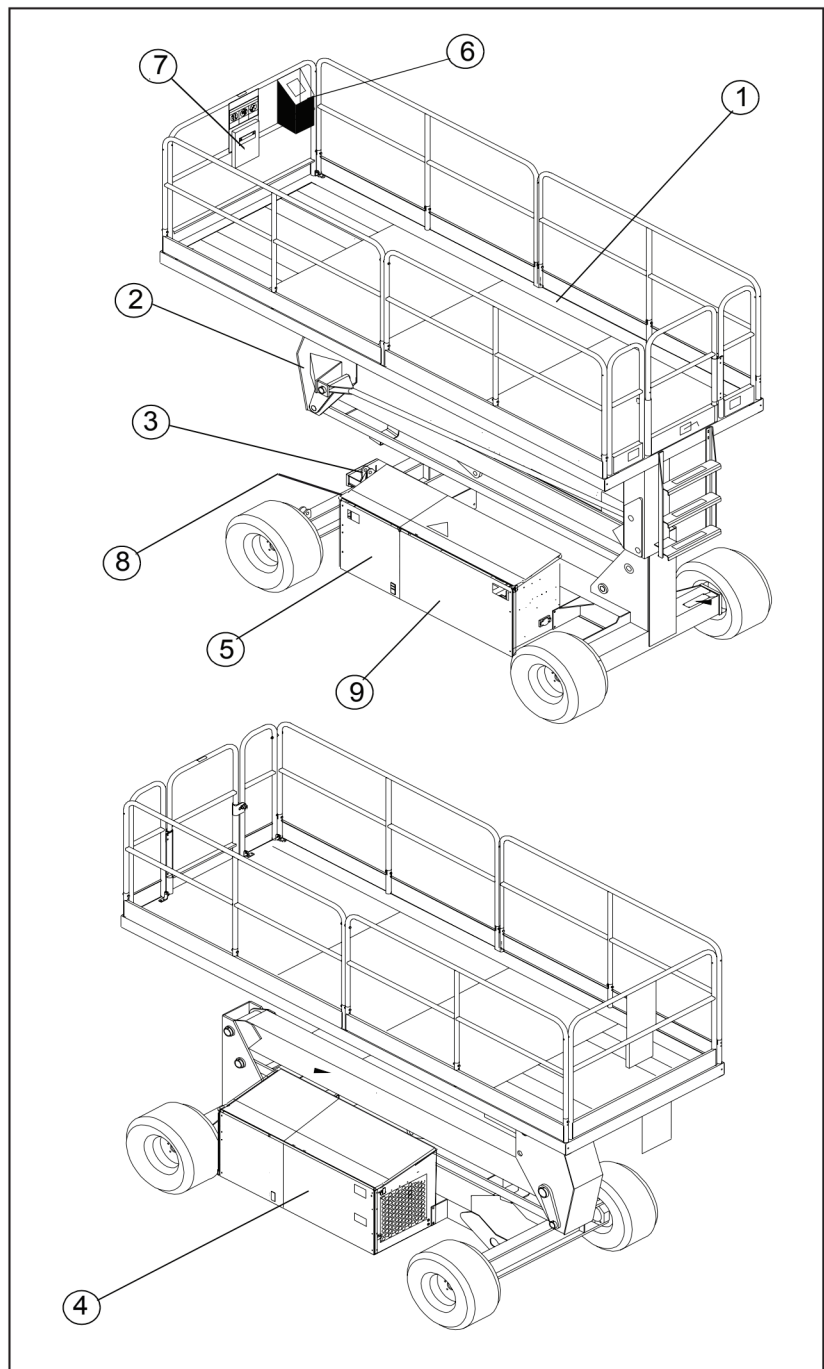
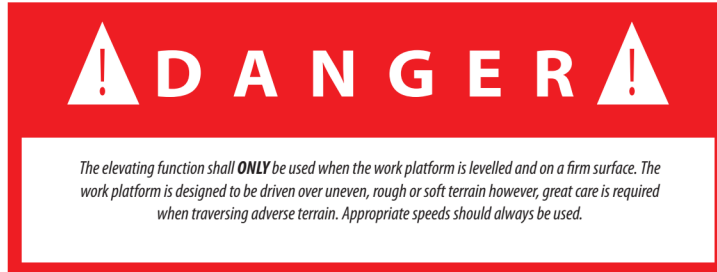

Figure 2: SL26/30 SL series

SPECIAL LIMITATIONS

SPECIAL LIMITATIONS

Travel with platform raised is limited to a maximum speed of 0.8 km/h (0.5 mph). Elevating the work platform is limited to firm surfaces only.



PLATFORM CAPACITY

The platform capacity for the machine including occupants is determined by model and options. This is listed under “specifications” on page 24.



MANUAL FORCE

Manual force is the force applied by the occupants to objects such as walls or other structures outside the work platform. The maximum allowable manual force is limited to 200N (45 lbs.) of force per occupant with a maximum of 400N (90 lbs.) for two or more occupants.



BEAUFORT SCALE

Beaufort Scale	m/Sec	Ground Conditions
3	3.5-5	Leaves and small twigs in constant motion; wind extends light flag.
4	6-8	Raises dust and loose paper; small branches are moved
5	9-10	Small trees in leaf begin to sway; crested wavelets on inland waterways.
6	11-13	Large branches in motion; umbrellas used with difficulty.
7	14-17	Whole trees in motion; inconvenience felt when walking against wind.
8	18-21	Breaks twigs off trees; generally impedes progress.
9	22-24	Slight structural damage occurs (chimney pots and slates removed)

Table 1: Beaufort scale

Never operate the machine when wind speed exceeds 12.5 m/s (28 mph) as indicated on the Beaufort scale.

LIFT OVERLOAD ALARM

If a load equivalent to 100% of safe working load is lifted, the overload LED's on the platform and ground control box will illuminate. However, If a load which is greater than the safe working load is placed on the platform, all machine functions will cease to operate and a warning alarm will sound.

To operate the machine, a load equal to or less than the safe working load must be placed on the platform. To re-start the machine functions, push down the emergency stop button to re-set and then release it to restore power.

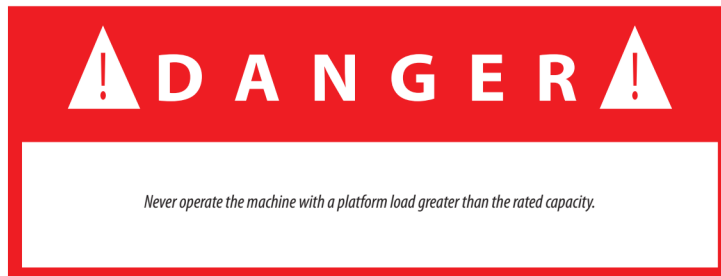

PLATFORM CONTROLS AND INDICATORS

1. Emergency stop button
2. Horn button
3. OFF/ON Engine start switch
4. Glow plug button
5. Engine warning LED
6. Low speed drive switch
7. Low speed drive enabled LED
8. Medium speed drive switch
9. Medium speed drive enabled LED
10. High speed drive switch
11. High speed drive enabled LED
12. Lift/Lower Switch
13. Lift/Lower enabled LED
14. Auto level switch
15. Platform tilt-steady red
Axle tilt - flashing red
16. Overload LED
17. Joystick
18. AC Generator Switch (Optional)

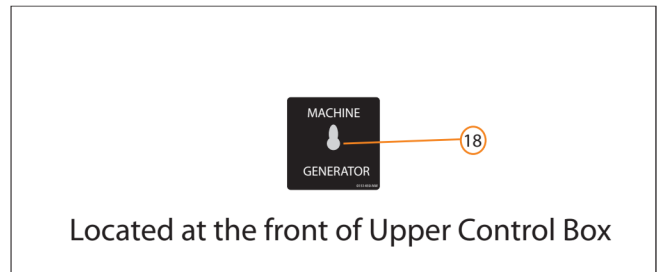
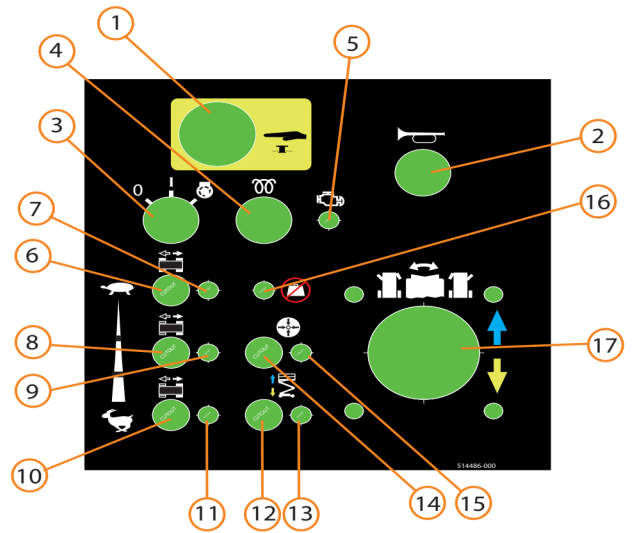

Figure 3: Platform controls and indicator locations

NOTE: Push Emergency stop button inward when the upper controls are not in use to protect against unintentional operation.

CHASSIS CONTROLS AND INDICATORS

1. Emergency stop button
2. Overload LED
3. Keyswitch: Platform/OFF/Chassis
4. Lift/Lower Switch
5. Enable Switch
6. Engine start button
7. Glow plug button
8. Display

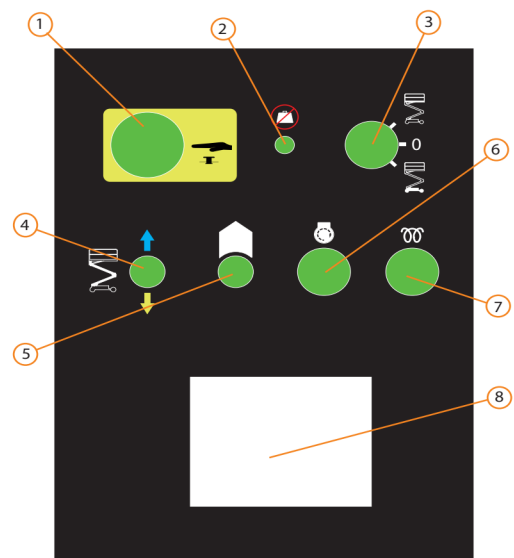

Figure 4: Chassis controls and indicator locations

PRE-OPERATION SAFETY INSPECTION

NOTE: Carefully read, understand and follow all safety rules, operating instructions, labels and National Safety Instructions/Requirements. Perform the following steps each day before use.

1. Open modules and inspect for damage, fluid leaks or missing parts.
2. ➤ Check the level of the hydraulic fluid with the platform fully lowered.
 - The hydraulic reservoir is located in the control module.
 - The fluid level must be between the minimum and maximum lines.
 - Add hydraulic fluid if necessary.
3. Check that the fluid level in the starter battery is correct.
4. ➤ Check the level of the diesel fuel with the engine switched off.
 - The fuel tank is located in the power module.
 - Add fuel as required.
5. Check that all guard rails are in place and all fasteners are properly tightened.
6. Inspect the machine thoroughly for cracked welds and structural damage, loose or missing hardware, hydraulic leaks, damaged control cables, loose wire connections and wheel bolts.



Figure 5: Hydraulic tank

NOTE: Check decal located on tank for Hydraulic fluid Specifications (refer to figure 5). Adding fluids of a different specification may cause operational problems.



To make the best use of power and performance from the engine, it is important to use fuel of the correct quality. The recommended fuel for the SL machines is diesel fuel with a minimum Cetane number of 45.

Refer to specifications on page 24 for suitable fuel information.

SYSTEM FUNCTION INSPECTION

Refer to figure 3 and 4 on page 10 for the locations of various controls and indicators.

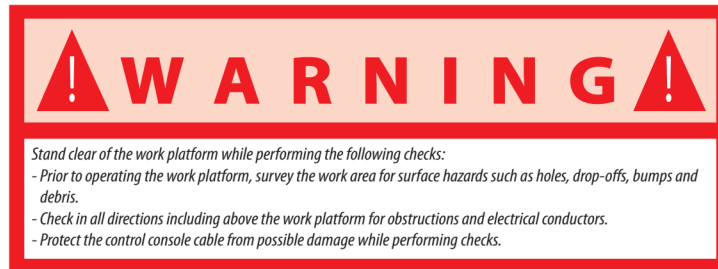

1. If necessary, move the machine to an unobstructed area to allow for full elevation.
2. Switch the battery isolator ON.
3. Twist the chassis emergency stop switch to the ON position.
4. Twist the platform emergency stop switch to the ON position.
5. Visually inspect;
 - The elevating assembly
 - Lift cylinders
 - Cables and hoses for cracked welds and structural damage
 - Loose hardware
 - Hydraulic leaks, loose wire connections and erratic operation.
 - Check for missing or loose parts.
6. Turn the key switch to the chassis control position
7. Start the engine by pressing the engine start button.

NOTE: If the engine is cold, you may need to press the glow plug button for a few seconds before starting the engine.

8. Raise and hold the enable toggle switch and then raise and hold the lift/lower switch to fully elevate the platform.
9. Partially lower the platform by raising the enable switch and lowering the lift/lower switch.
10. Open the Emergency lowering valve (refer to figure 8) by pulling the knob out to check for proper operation. When the platform is lowered, release the knob.
11. Push the chassis emergency stop switch to check for proper operation. All machine functions should be disabled. Twist the chassis emergency stop switch to resume.
12. Check that the route is clear of obstacles (persons, obstructions, holes and drop-offs, bumps and debris), is level and capable of supporting the wheel loads.
13. Turn keyswitch to upper control position.
14. Mount the platform and properly close the entrance.
15. Start the engine from the platform controls.
16. Select low speed drive mode.

NOTE: Use both high and low drive (if applicable) when performing the following steps.

17. While engaging the safety interlock trigger, move the joystick forward then reverse to check for speed control.
18. Push the steering switch right then left to check for steering control.
19. Repeat for medium and high speed drive.
20. Select LIFT mode. Grasp the joystick engaging the safety interlock trigger and push it forward to check platform lift controls. Raise the platform to full elevation.
21. Pull back on the joystick. The platform should descend and the audible lowering alarm should sound.
22. Push the platform emergency stop switch to check for proper operation. All machine functions should be disabled. Pull out the platform emergency stop switch to resume.

NOTE: Push Emergency stop button inward when the upper controls are not in use to protect against unintentional operation.

Before operating the work platform, ensure that the pre-operation safety inspection has been completed and that any deficiencies have been corrected. **Never operate a damaged or malfunctioning machine.** The operator must be thoroughly trained on this machine.

STARTING THE MACHINE

1. Turn the key switch to the platform position.
2. Mount the platform and properly close the entrance.
3. If the engine is cold, press down and hold the “glow plug button” for approximately 5 seconds.
4. Select engine start and hold until the engine is running.

STEERING

NOTE: Steering is not automatically centred. wheels must be returned to straight ahead position by operating the steering switch.

1. Select a DRIVE mode.
2.
 - While engaging the safety interlock trigger, push the steering switch to right or left to turn the wheels in the desired direction.
 - Observe the tyres while manoeuvring the machine to ensure it moves in the correct direction.

ELEVATING THE PLATFORM

NOTE: If the chassis inclination limit is exceeded and the platform is elevated above approximately 2m (6 ft), the tilt alarm will sound and the machine will not lift or drive. If the tilt alarm sounds, the platform must first be fully lowered and then approximately elevated to 600mm (2ft). Press and hold the auto level switch and then engage the safety interlock trigger until the tilt LED extinguishes. If the platform is not levelled correctly, the tilt alarm will continue to sound and the lift functions will be cut off.

1. Check clearances below and to the sides of the platform.
2. Select lift mode.
3. While engaging the safety interlock trigger, push the joystick forward.

LOWERING THE PLATFORM

1. Check clearances below and to the sides of the platform.
2. Select LIFT mode.
3. Engage the safety interlock trigger and pull back on the joystick to lower the platform.

TRAVEL WITH THE PLATFORM LOWERED

1. Check that the route is clear of obstacles (persons, obstructions, holes, drop-offs, bumps and debris) and capable of supporting wheel load.
2. Ensure that the chassis emergency stop switch is ON (pulled out).
3. Mount the platform and properly close the entrance.
4. Check clearances above below and to the sides of the platform.
5. Twist the platform emergency stop switch out to the ON position.
6. Start the machine and select a DRIVE mode.

NOTE: Choose between standard drive, high, low and extra torque depending on the gradient.

NOTE: Stow the main boom before driving the machine to reposition it when operating on uneven surfaces. With the boom stowed, the front axle pivots to keep all four wheels in contact with the ground surface.

7. High speed select option on the platform controls is for 2-wheel drive only. Low speed maximum torque select option is for 4-wheel drive only.
8. High speed should only be used to cover longer distances over firm level ground. It is not intended to be used for precise manoeuvring or positioning.
9. Engage the safety interlock trigger and move the joystick to forward or reverse to travel in the desired direction. The speed of the machine will vary depending on how far from centre the joystick is moved.

OPERATION

TRAVEL WITH THE PLATFORM ELEVATED

NOTE: The machine will travel at reduced speed when the platform is elevated.

1. Check that the route is clear of obstacles (persons, obstructions, holes, drop-offs, bumps and debris) and capable of supporting the wheel load.
2. Check clearances above, below and to the sides of the platform.
3. Select DRIVE mode.
4. Engage the safety interlock trigger on the joystick and move forward or reverse to travel in the desired direction. The speed of the machine will vary depending on how far from centre the joystick is moved.
5. If the machine is not level, the tilt alarm will sound and the machine will not lift or drive. If the tilt alarm sounds, the platform must be lowered and the platform levelled (see below) before attempting to re-elevate the platform.

LEVELLING THE PLATFORM

The auto level feature is designed to level the platform in a situation where the ground has no more than a 13 degree slope side to side and 9 degrees front and back. If the slope is greater than 13 degrees side to side and 9 degrees front and back, the “auto level” feature will not function. The tilt alarm will continue to sound until the platform is level.

1. Check that the route is clear of obstacles (persons, obstructions, holes, drop-offs, bumps and debris) and capable of supporting wheel load.
2. Check clearances above, below and to the sides of the platform.
3. Elevate the platform approximately 600mm (2ft).
4. Press and hold the “auto level” and engage the safety interlock trigger until the platform is level, the tilt alarm is silenced and the tilt LED extinguished.
5. The machine can now be driven within the limits of the tilt sensor. If the terrain changes, the machine will stop and the platform must be lowered and re-levelled.

NOTE: This machine has a floating axle which locks when elevated above approximately 2m (6ft). If the machine is elevated and the ground slope causes the floating axle to be out of level when compared to the fixed axle, drive will be disabled. This will be indicated by the tilt LED flashing red. In this event, lower the platform below 2m (6ft) to enable drive.

HOUR METER

The runtime hours are displayed on the chassis control panel.

AC GENERATOR(OPTIONAL)

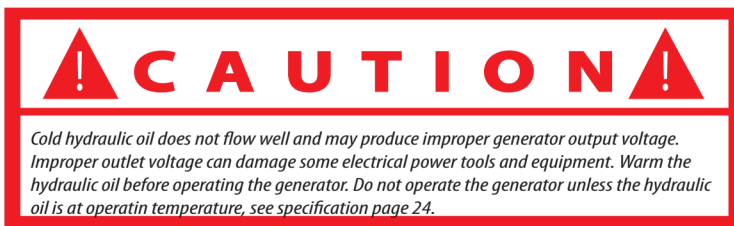

The Switch for the optional AC generator is located on the front of the upper control panel (refer to page 10). With the engine running, place the switch on the upper control panel to the “GENERATOR” (down position) to provide electrical power to the electrical outlets in the platform. Machine functions will not operate while the switch is in the “GENERATOR” position.

NOTE: The engine will run at high idle while the generator is operating.

Return the switch to the “MACHINE” (up position) to turn off the generator and resume machine operation.

The optional generator supplies power to the electrical outlets only when the engine is running and the machine is stationary. The machine functions will not operate when the generator switch is in the “GENERATOR” position.

Electrical Power Outlet (Optional)

Power may be supplied to the outlet using an external power source or by operating the optional AC generator.

PLATFORM EXTENSION (SL26 SPEED LEVEL ONLY)

The platform can be extended and securely locked into position. Use the following procedure to extend the platform:

1. Enter the platform and close the gate.

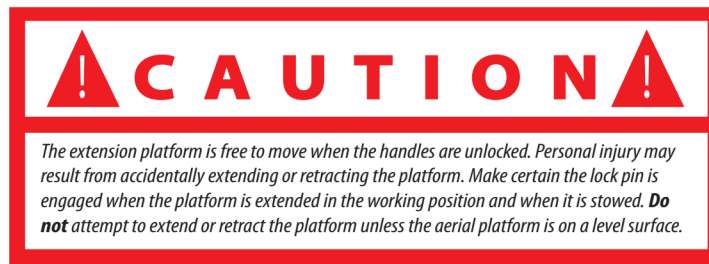

2. While facing the front of the platform, unlock the LH and RH handles on the extension platform. Using the handles, slide the extension platform out. Ensure that the LH and RH are locked securely in place.
3. Try to move the rails back and forth to make sure the platform extension is locked in place.

PLATFORM RETRACTION(SL26 SPEED LEVEL ONLY)

1. Enter the platform and close the gate.

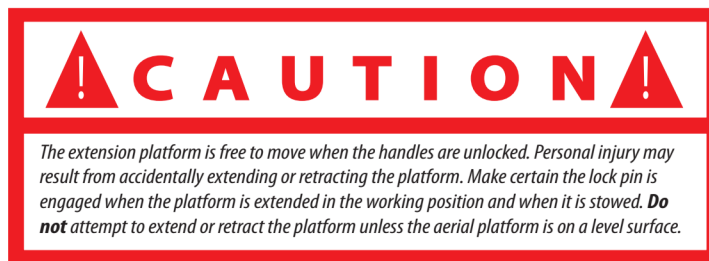

2. While facing the front of the platform, unlock the LH and RH handles on the extension platform. Using the handles, slide the extension platform in. Ensure that the LH and RH are locked securely in place.
3. Try to move the rails back and forth to make sure the platform extension is locked in place.

FOLD DOWN GUARDRAILS

This procedure is for the purpose of transportation. Guardrails must be returned to the upright position (safe working position) before using the machine.

FOLD DOWN PROCEDURE

1. Retract extension platform by releasing securing pins and sliding extension platform into locking position.
2. Unhook the controller from the side guardrail and place it on the floor of the platform.
3. Starting at the front of the platform, remove nuts, bolts and washers from the top of the front guardrail. Fold the front guardrail down onto the platform.
4. Close the latch gate.
5. Remove nuts, bolts and washers from the top of the rear guardrail. Fold the rear guardrail down onto the platform being careful to keep latched at all times.
6. Remove nuts, bolts and washers from the top of the side guardrails. Lift up and fold one side guardrail in resting it on the deck. Repeat with other side guardrails.

UNFOLD PROCEDURE

OPERATION

1. Raise side guardrails, making sure each is pushed down to secure the guardrail in the vertical position.
2. Install bolts, washers and nuts between the side guardrails, tighten securely.
3. Raise rear guardrail assembly, aligning holes and install bolts, washers and nuts. Tighten securely.

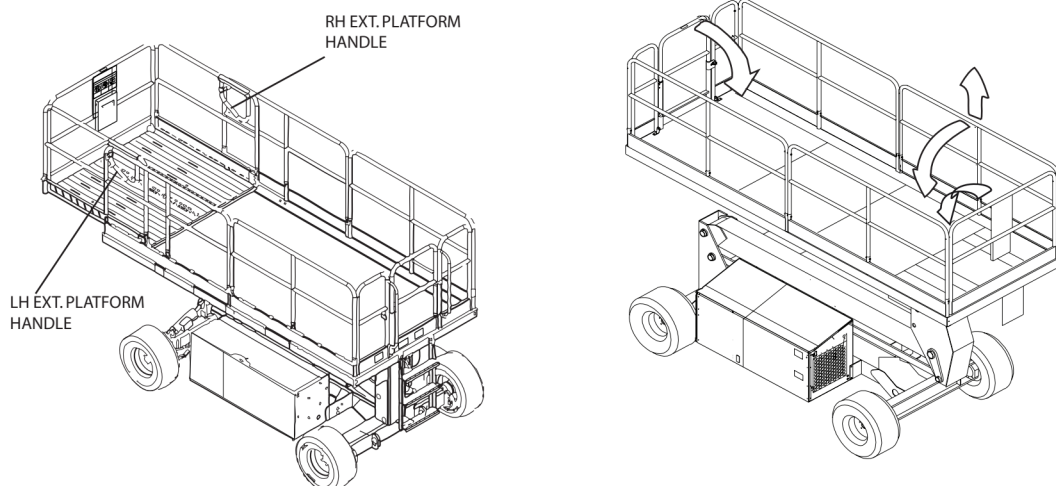
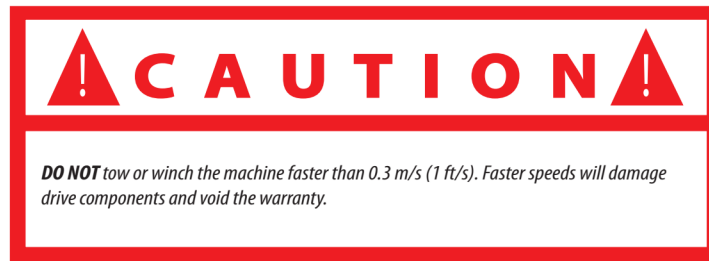

Figure 6: A view of the platform handle locations and fold directions.

TOWING OR WINCHING

Perform the following action only when the machine will not operate under its own power and it is necessary to move the machine or when winching onto a transport vehicle (Refer “Transporting the work platform” on page 20).



BRAKE RELEASE PUMP

Perform the following only when the machine will not operate under its own power and it is necessary to move the machine or when towing the machine up a grade or onto a trailer to transport.

1. Open the needle valve by turning the screw anti-clockwise. This allows the wheels to free-wheel.
2. Pump the brake release pump until the parking brake is released.
3. The machine will be able to roll when pushed or pulled.
4. Be sure to close the needle valve and screw in the PC3 valve with an allen key after undoing the locknut. This will release the brake pressure. Once the brakes have been re-applied, return PC3 valve to its original configuration by fully unscrewing. Finally tighten the locknut.

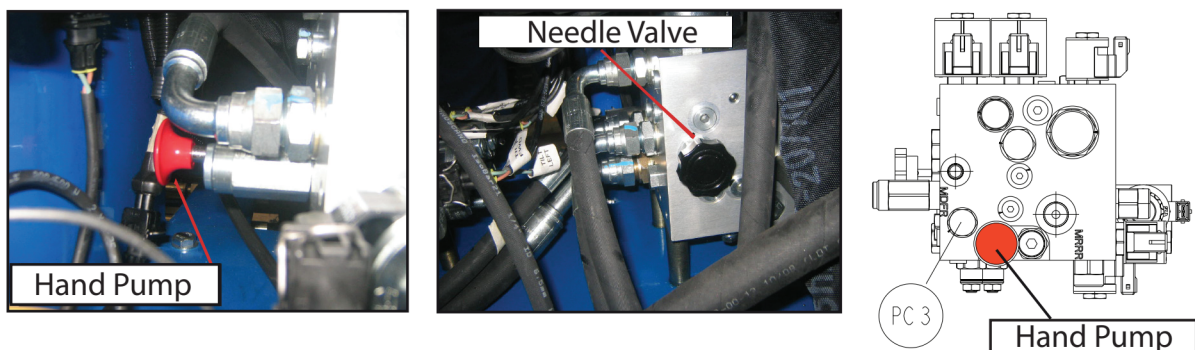
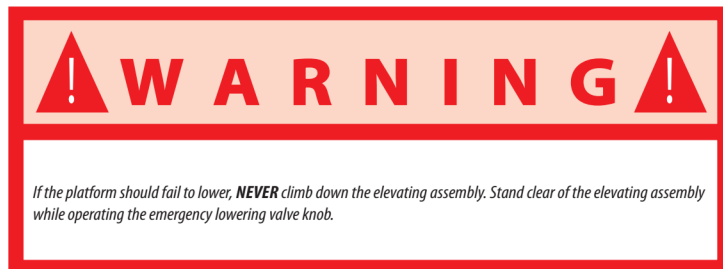

Figure 7: A view of the hand pump and needle valve locations.

EMERGENCY PROCEDURE



EMERGENCY LOWERING



The emergency lowering valve for the SL machine is located on the module side as shown in figure 8.

1. Open the emergency lowering valve by pulling and holding the handle.
2. To close, release the handle.

NOTE: The platform will not elevate if the emergency lowering valve is open.



Figure 8: Emergency Lowering handle.

PREPARATION FOR SHIPMENT

1. Fully lower the platform.
2. Turn batteries OFF with master switch.

LIFTING BY CRANE

1. Secure straps to chassis tie down/lifting lugs only.
2. Place the platform onto the transport vehicle in transport position.
3. Chock the wheels.
4. Secure the work platform to the transport vehicle with chains or straps of adequate load capacity attached to the chassis tie down/lifting lugs.

DRIVING OR WINCHING ONTO A TRACK OR TRAILER

NOTE: Do not winch faster than 0.3 m/s (1 ft/s)

1. Move the machine onto the truck or trailer using the following procedure:
 - To drive the machine onto the transport vehicle;
 - Move the work platform up the ramp and into transport position.
 - Set the wheels straight and turn off the machine.
 - Chock the wheels.
 - To winch the machine onto the transport vehicle;
 - Move the work platform up to the ramp.
 - Attach the winch cable to the tie down/lifting lugs.
 - Release the parking brakes. Refer to towing or winching on page 17.
 - Winch the platform into transport position.
 - Chock the wheels.
2. Secure the work platform to the transport vehicle with chains or straps of adequate load capacity attached to the chassis tie down/lifting lugs.

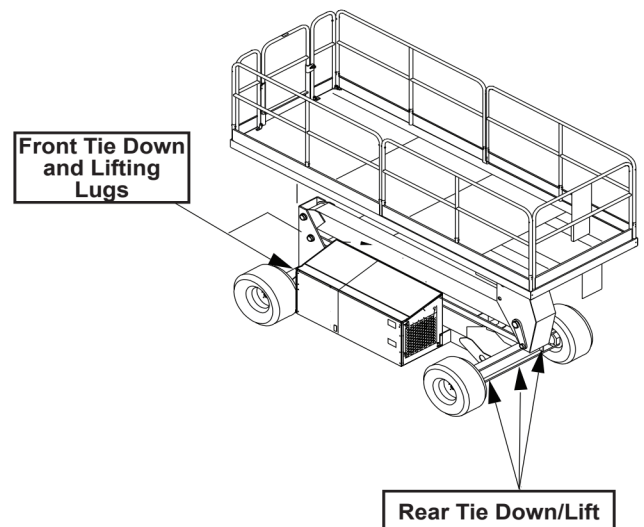

Figure 9: Transporting the work platform.



AFTER USE EACH DAY

1. Ensure that the platform is fully lowered.
2. Park the machine on a firm level surface, preferably under cover, secure against vandals, children and unauthorized operation.
3. Turn the chassis key switch to OFF and remove the key to prevent unauthorized operation.
4. Turn batteries OFF with master switch.

! W A R N I N G !

*Never perform service while the platform is elevated without first blocking the elevating assembly. **DO NOT** stand in the elevating assembly area while deploying or removing the jackstand.*

BLOCKING THE ELEVATING ASSEMBLY

INSTALLATION

1. Park the work platform on firm, level ground and leave the engine running.
2. Ensure the chassis emergency stop button is twisted to the ON position.
3. Press and hold the chassis ENABLE and then LIFT switches to elevate the platform approximately 305mm (12 inches).
4. Place a jackstand with a minimum rating of 2000 kg (4000 lbs.) between the lower mast and chassis just behind the front axle.
5. Press and hold the chassis ENABLE and then DESCEND switches to lower the platform until jackstand is secured tightly between the lower mast and chassis.

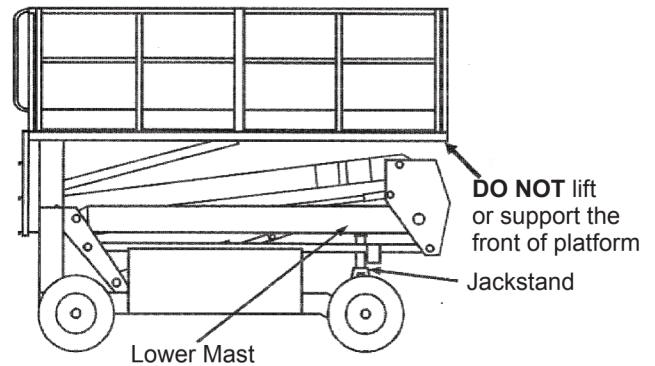

Figure 10: Jackstand location.

REMOVAL

1. Press and hold the chassis ENABLE and then LIFT switches to elevate the platform until the jackstand can be removed.
2. Remove the jackstand.
3. Press and hold the Chassis ENABLE and the DESCEND switches to completely lower the platform.

BATTERY MAINTENANCE (FOR MAINTENANCE BATTERIES ONLY)

! W A R N I N G !

*Hazard of explosive gas mixture. Keep sparks, flame and smoking material away from batteries.
Always wear safety glasses when working near batteries.
Battery fluid is highly corrosive. Thoroughly rinse away any spilled fluid with clean water.
Always replace batteries with Snorkel batteries or manufacturer approved replacements.*

- Check the battery fluid level daily, especially if the work platform is being used in a warm, dry climate.
- If electrolyte level is lower than 10mm (3/8 in.) above the plates, add distilled water only. DO NOT use tap water with high mineral content as it will shorten battery life.
- Keep the terminals and tops of the batteries clean.
- Refer to the service manual to extend battery life and for complete service instructions.

BATTERY CHARGING

The battery charges while the engine is running.

INSPECTION AND MAINTENANCE

The complete inspection consists of periodic visual and operational checks along with periodic minor adjustments that assure proper performance. Daily inspection will prevent abnormal wear and prolong the life of all systems. The inspection and maintenance schedule should be performed by personnel who are trained and familiar with mechanical and electrical procedures.



The daily preventative maintenance checklist has been designed for machine service and maintenance. Photocopy the checklist page and use the checklist when inspecting the machine.

DAILY PREVENTATIVE MAINTENANCE SCHEDULE

MAINTENANCE TABLE KEY

Y = Yes/Acceptable
N = No/Not Acceptable
R = Repaired/Acceptable

PREVENTATIVE MAINTENANCE REPORT

Date: _____
 Owner: _____
 Model #: _____
 Serial #: _____
 Serviced by: _____

COMPONENT	INSPECTION OR SERVICES	Y	N	R
Operator's Manual	Check that the operators manual is in the manual holder and all pages are intact and readable			
Labels & Decals	Check that labels and decals are in place, intact and readable			
Entire Unit	Perform pre-operation inspection			
	Check for and repair any damage			
Electrical system	Check cables and wiring harness condition (No wear or physical damage)			
Battery System	Check electrolyte level			
	Check battery cable condition			
	Check terminals are clean and connectors are tight			
	Check charger condition and operation			
	Charge batteries			
Hydraulic fluid	Check oil level			
Hydraulic system	Check all fittings are tight and there are no leaks			
Drive motors	Check for operation and leaks			
Generator (Optional)	- Check cables and wiring harness condition (No wear or physical damage) - Check fittings are secure and there are no leaks			
Hydraulic pump	Check fittings are secure and there are no leaks			
Emergency lowering	Check emergency lowering correctly (See emergency lowering procedure)			
Controller	Check condition and operation			
Platform deck and rails	Check fasteners are in place, correctly tightened and not damaged			
	Check the structure and welds for damage, deformation, corrosion and cracks			
	Check condition of deck (no damage, deformation, corrosion or cracks)			
	Check entry gate closure functions correctly			

COMPONENT	INSPECTION OR SERVICES	Y	N	R
Elevating assembly	Inspect for external damage, dents, loose rivets or cracks.			
	Check the structure and welds for damage, deformation, corrosion and cracks			
Chassis	Check cables for pinch or rubbing points			
	Check the structure and welds for damage, deformation, corrosion and cracks			
Lift Cylinders	Check for leaks			
Wheels	Check for loose components			
	Check for damage to tyres			
Harness anchor point	Check fasteners are secure			
	Check for damage, deformation, corrosion and cracks			
System function inspection	Conduct system function inspection (see system function inspection procedure)			
Emergency stops	Check that the emergency stop button on the basket panels operates correctly			
	Check that the emergency stop button on the ground control panel operates correctly			
Brakes	Check that the brakes operate correctly			
Horn	Check that the horn sounds when activated			
Controller and Sensors	Check that the level sensor functions correctly (drive and platform raise functions are disabled and only platform lowering enabled) when the platform inclination exceeds the specification inclination value.			
	Check full drive speed range is enabled when the platform is stowed.			
	Check that only reduced drive speed range is enabled when the platform is elevated.			

Table 2: Daily preventative maintenance checklist

*** NOTE: Use ISO #46 during summer and ISO #32 during winter**

SPECIFICATIONS

ITEM	SL26SL	SL30SL
PLATFORM SIZE (INSIDE TOEBOARDS)		
STANDARD	1.71 m x 3.66 m [67.5 in. x 144 in.]	1.71 m x 4.22 m [67.5 in. x 166.5 in.]
SLIDE OUT DECK EXTENDED	1.71 m x 4.55 m [67.5 in. x 179 in.]	N/A
MAXIMUM PLATFORM CAPACITY		
STANDARD	680 kg [1500 lbs.]	590 kg [1300 lbs.]
w/EXTENSION	680 kg [1500 lbs.]	N/A
On EXTENSION	225 kg [496 lbs.]	N/A
MAXIMUM NUMBER OF OCCUPANTS		
STANDARD	5 PEOPLE (WIND SPEED 12.5 m/s)	5 PEOPLE (WIND SPEED 12.5 m/s)
On EXTENSION	2 PEOPLE (WIND SPEED 12.5 m/s)	N/A
HEIGHT		
WORKING HEIGHT	9.75 m [32 ft.]	10.85 m [35.6 ft.]
MAXIMUM PLATFORM HEIGHT	7.90 m [26 ft.]	9.0 m [29.5 ft.]
MINIMUM PLATFORM HEIGHT	1.5 m [59 in.]	1.5 m [59 in.]
MAXIMUM DRIVE HEIGHT	7.90 m [26 ft.]	9.0 m [29.5 ft.]
DIMENSIONS		
WEIGHT	DIESEL: 3550 kg [7826 lbs.]	DIESEL: 3400 kg [7495 lbs.]
OVERALL WIDTH, STANDARD	2.13 m [84 in.]	2.13 m [84 in.]
OVERALL HEIGHT	2.6 m [102.5 in.]	2.6 m [102.5 in.]
OVERALL LENGTH, STANDARD	3.79 m [149 in.]	4.39 m [173 in.]
SURFACE SPEED		
PLATFORM LOWERED HIGH/LOW	0 TO 5.0 km/h [0 TO 3.1 m.p.h.]	0 TO 5.0 km/h [0 TO 3.1 m.p.h.]
PLATFORM RAISED	0 TO 0.8 km/h [0 TO 0.5 m.p.h.]	0 TO 0.8 km/h [0 TO 0.5 m.p.h.]
SYSTEM VOLTAGE	12 VOLT DC	12 VOLT DC
HYDRAULIC TANK CAPACITY	74 L [19.5 US GALLONS]	47 L [19.5 US GALLONS]
MAXIMUM HYDRAULIC SYSTEM PRESSURE	210 bar [3000 psi]	210 bar [3000 psi]
HYDRAULIC FLUID		
ABOVE 32°F [0°C]	ISO #46 (SEE DECAL ON TANK)	ISO #46 (SEE DECAL ON TANK)
NORMAL USE, BELOW 32°F [0°C]	ISO #32	ISO #32
BELOW 0°F [-17°C]	ISO #15	ISO #15
LIFT SYSTEM	ONE SINGLE STAGE LIFT CYLINDER	ONE SINGLE STAGE LIFT CYLINDER
LIFT SPEED	RAISE: 21 SECONDS/LOWER: 32 SECONDS	RAISE: 24 SECONDS/LOWER: 36 SECONDS
PLATFORM LEVELLING	13° SIDE TO SIDE, 9° FRONT AND BACK	13° SIDE TO SIDE, 9° FRONT AND BACK
POWER SOURCE	20 HP (DIESEL), 15 kW	20 HP (DIESEL), 15kW
DRIVE CONTROL	PROPORTIONAL	PROPORTIONAL
CONTROL SYSTEM	JOYSTICK CONTROLLER WITH SAFETY	JOYSTICK CONTROLLER WITH SAFETY
	INTERLOCK TRIGGER AND THUMB ROCKER	INTERLOCK TRIGGER AND THUMB ROCKER
	STEERING, TOGGLE SELECTOR	STEERING, TOGGLE SELECTOR
	EMERGENCY STOP SWITCHES	EMERGENCY STOP SWITCHES
HORIZONTAL DRIVE	FOUR WHEEL, HYDRAULIC MOTORS	FOUR WHEEL, HYDRAULIC MOTORS
TYRES (STANDARD)	26 x 12.00 - 12 SUPER TERRA-GRIP WITH TRAC SEAL	26 x 12.00 - 12 SUPER TERRA - GRIP WITH TRAC SEAL
ANSI SPECIFICATION PNEUMATIC TYRE PRESSURE	DO NOT EXCEED 57 PSI	DO NOT EXCEED 57 PSI
PARKING BRAKES	DUAL SPRING APPLIED, HYDRAULIC RELEASE, MULTI DISC	DUAL SPRING APPLIED, HYDRAULIC RELEASE, MULTI DISC
TURNING RADIUS (INSIDE)	3.96 m [13 ft.]	3.96 m [13 ft.]
MAXIMUM GRADEABILITY	50% [27°]	50% [27°]
WHEEL BASE	2.54 m [100 in.]	2.54 [100 in.]
GUARDRAILS	1.7 m [67 in.] HIGH, FOLD DOWN WITH GATE	1.7 m [67 in.] HIGH, FOLD DOWN WITH GATE
TOEBOARD	152 mm [6 in.] HIGH	152 mm [6 in.] HIGH

SPECIFICATIONS

WHEEL LOADING	2000 kg (4400 lb)	2000 kg (4400 lb)
VIBRATION OF THIS MACHINE DOES NOT EXCEED	2.5 m/s ²	2.5 m/s ²
NOISE PRESSURE LEVEL	107 dB AT CONTROL STATION	107 dB AT CONTROL STATION
MACHINE VIBRATION	WHOLE BODY VIBRATION < 0.5 m/s ² , HAND ARM VIBRATION < 2.5 m/s ²	WHOLE BODY VIBRATION < 0.5 m/s ² , HAND ARM VIBRATION < 2.5 m/s ²
OPTIONAL AC GENERATOR	115/230V,3.5KvA,3000RPM,50hz	115/230V,3.5KvA,3000RPM,50hz

Table 3: SL26SL/SL30SL Specification

NOTE: Specifications are subject to change without notice. Hot weather or heavy use may affect performance. Refer to the service manual for complete parts and service information. This machine meets or exceeds all applicable OSHA and ANSI A92.6 - 1999.

**Local Distributor / Lokaler Vertiebs Händler / Distributeur local
El Distribuidor local / Il Distributore locale**

**EUROPE, MIDDLE EAST
AFRICA & ASIA**

PHONE: +44 (0) 845 1550 057

FAX: +44 (0) 845 1557 756

NORTH & SOUTH AMERICA

PHONE: +1 785 989 3000

TOLL FREE: +1 800 225 0317

FAX: +1 785 989 3070

AUSTRALIA

PHONE: +61 2 9725 4000

FAX: +61 2 9609 3057

NEW ZEALAND

PHONE: +64 6 3689 168

FAX: +64 6 3689 164

 **snorkel**
www.snorkellifts.com

